

Data Sheet

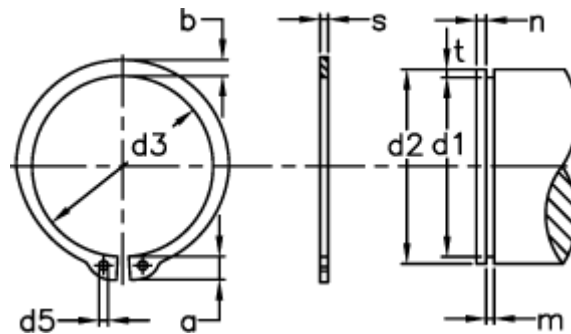

Article number: 0109055
 Description: Retaining ring AS 38x2.5
 Spring steel
 Note: Fitted with ZGA pliers

Measures



a max	= 6.8	Description	= AS 38	s	= 2.50
AN mm ²	= 127.0	FN kN	= 21.20	t	= 1.00
B	= 2.04	FRg kN	= 18.6	tol	= -0.25
b	= 4.3	FR kN	= 101.0	tol	= -0.07
d1	= 36.0	g	= 2.0	tol	= +0,25 -0,50
d2	= 38	m min	= 2.65	Tong	= ZGA-3
d3	= 35.2	n abl x 1000	= 15	Weight kg/1000	= 8.00
d5 min	= 2.5	Nominal drive	= 3.3		